



***XCNAV***

***EDITION***

***Vers.:1.0 11/25/22***

## *User manual*

### *1. General*

#### *1.1 Control and operation*

##### *1.1.1 Hardware buttons*

#### *1.2 Open settings*

#### *1.3 Setting the screen brightness*

### *2. Start screen*

#### *2.1 Navigation bar*

#### *2.2 Status bar and "QuickAccess" menu*

#### *2.3 Changing the screen background*

#### *2.4 Moving an app to the start screen*

#### *2.5 Widgets*

### *3.0 APPS*

#### *3.1 Install an App*

#### *3.2 Uninstall/Delete an App*

### *4. Settings*

*-TBD-*

## *5. Connectors*

### *5.1 Rear connectors*

#### *5.1.1 5V OUT*

#### *5.1.2 USB 2.0*

#### *5.1.3 Port S1*

#### *5.1.4 Port S2*

#### *5.1.5 11-35V V IN*

### *5.2 Side panel connectors*

#### *5.2.1 SimCard slot*

#### *5.2.2 USB connections*

#### *5.2.3 SD card terminal*

#### *5.2.4 HDMI connection 2nd seat*

#### *5.2.5 Audio out*

## *6. Connection of peripheral devices*

### *6.1 XCVario connection*

### *6.2 Flarm connection*

### *6.3 LX S8X/10X connection*

### *6.4 LX EOS 57/80 connection*

### *6.5 KRT 2 radio connection*

## *6.6 Connection example of XCVario, XCRemote and KRT2*

*7. Mounting and electrical connection*

*8. Technical data*

*9. Guarantee conditions*

*10. Approval*

*11. Limitation of liability and CE declaration of conformity*

## 1.1 Control/Operation

Your edition has a 5-point PCap touch screen as known from smartphones. The touch gestures make it extremely simple and intuitive.

### 1.1.1 Hardware buttons

XCNAV EDITION also has 4 hardware buttons (Fig.1).



Fig.1

These are assigned as follows:



Short: ENTER / Long: QUICKMENU in XCSOAR



1x short: arrow key up/down(ZOOM in XCSOAR and LK8000);

2x short: Volume +/-

Long: Screen brightness +/-



1x short: ESC

2x short: Reset Keypadcontroller

Long: XCSoar Exit Menu in XCSoar

## 1.2 Open settings.

There are 2 ways to open the settings menu:

1. Open settings in the APP overview (Fig.2). To do this, swipe up from the bottom of the home screen and select Settings.

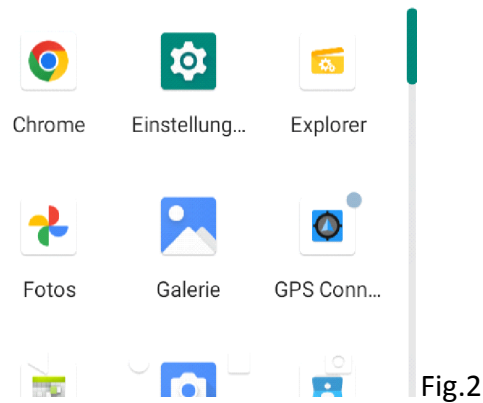

2. Swipe down 2X from the top of the screen. On the extended Quick Access Panel (Fig.3). Selecting the pictogram opens the settings.

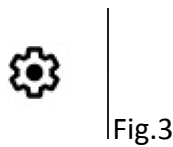

### 1.3 Setting the screen brightness

1.As described under 1.1.1 by pressing and holding the hardware arrow keys. The brightness slider appears (Fig.4). The hardware keyboard regulates in 10 steps (each 1/press&hold) from 0 to 100%. The slider can be used for finer adjustment.



2. Swipe twice from the top edge of the screen to open the expanded Quick Access Menu. There is also a slider for brightness control on the top. (Fig.5)

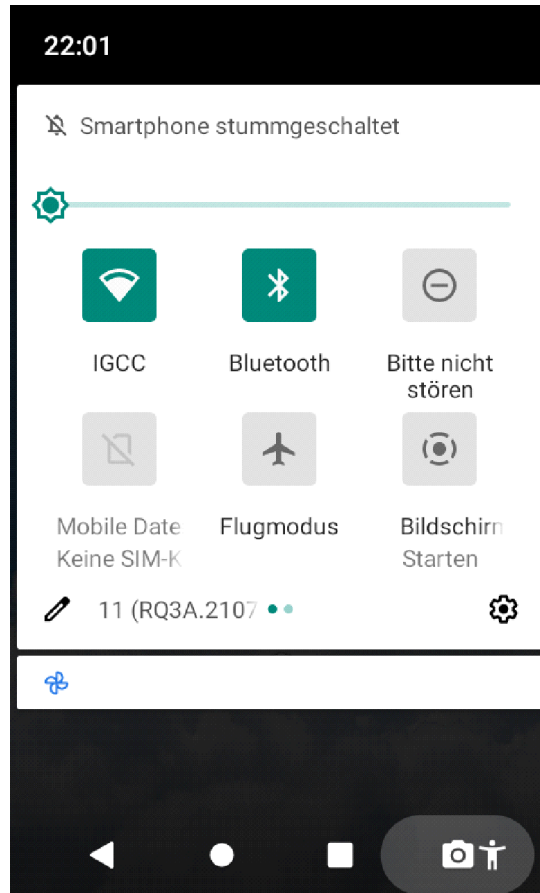

Fig.4

Fig.5

## 2. Home screen

The home screen is what you see after turning on your XCNAV Edition. This can be designed and configured individually.

### 2.1 Navigation bar

The navigation bar (Fig.1) is used for navigating through the Android user interface in addition to the swipe gestures. The behavior can be set under "SETTINGS" - "DISPLAY". The functions apply to all APPs!

**IMPORTANT: while XCSOAR and LK8000 are running! Swipe up from the very bottom edge of the screen to reveal them again!**



Depending on the set DPI value (display size), only parts of the navigation bar can be shown (Fig.2)



Fig.1 (DPI

value 160)



Fig.2 (DPI value 240)

The basic functions are as follows:

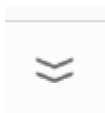

Hide navigation bar down



BACK: Goes one step/level back (e.g. in menus)

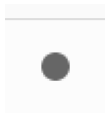

HOMEBUTTON: Returns to the Android home screen



APPSWITCHER: Opens an overview of all open apps.

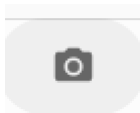

SCREENSHOT BUTTON: Takes a screenshot. Button can be toggled on/off under SETTINGS->SCREENSHOT VOLUME



CONTROL



POWER BUTTON. Turning off/restarting your XCNAV EDITION

## 2.2 Status Bar and "Quick Access" Menu

At the top of the screen is the status bar (Fig.3). The time and the connection status of WIFI, LTE and BT are displayed here, as well as other app notifications.



Fig.3

With a downward swipe gesture over the status bar, the Quick Access Panel opens (Fig.4). Certain functions such as WIFI, BT etc can be switched on and off here. Function fields with a green background mark active services. Current notifications and app status messages can also be seen here.

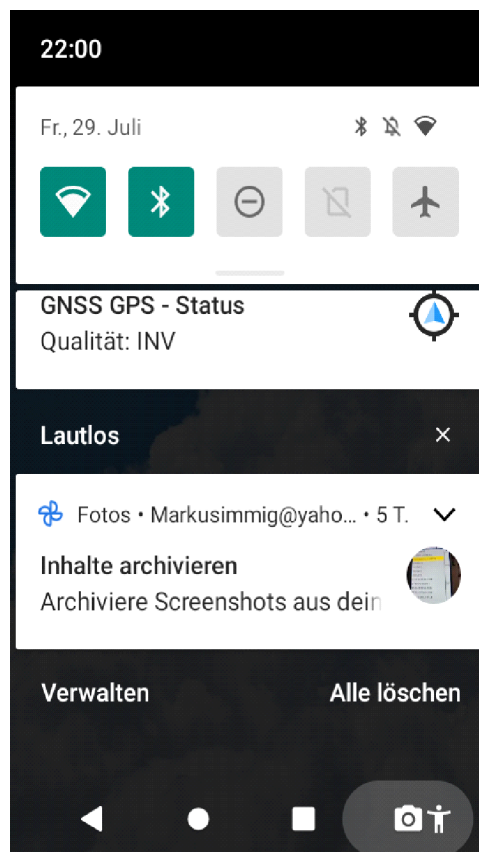

swiping

The quick access panel(Fig.5) Among other things, the display brightness can be set here.

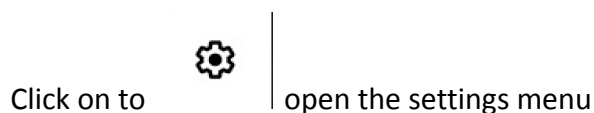

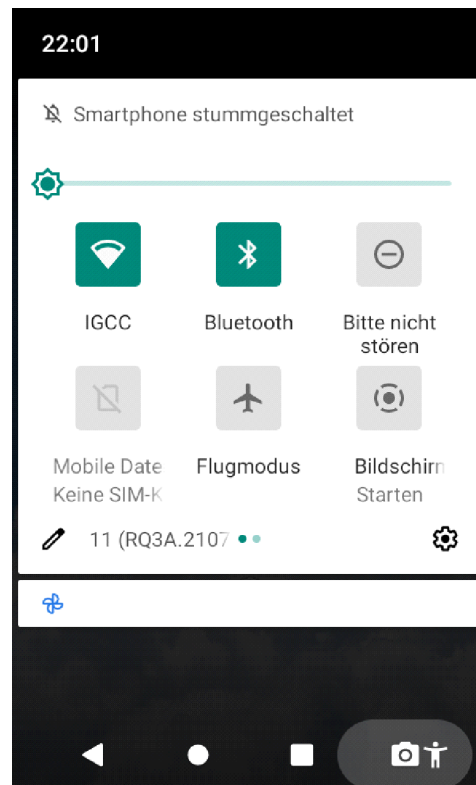

Fig.5

## 2.3 Changing the homescreen wallpaper

Two XCNAV background "wallpapers" are stored up on delivery, but you can transfer your own additional images to the device in order to use them as screen backgrounds. Size 800x480px. To select a wallpaper, touch and hold your finger anywhere on the home screen.that now opens, menu click on "Backgrounds" (Fig. 1.) -> "System Wallpapers" and select the appropriate photo as the background. Confirm the selection as home screens in the preview. A lockscreen is not used in the XCNAV configuration.

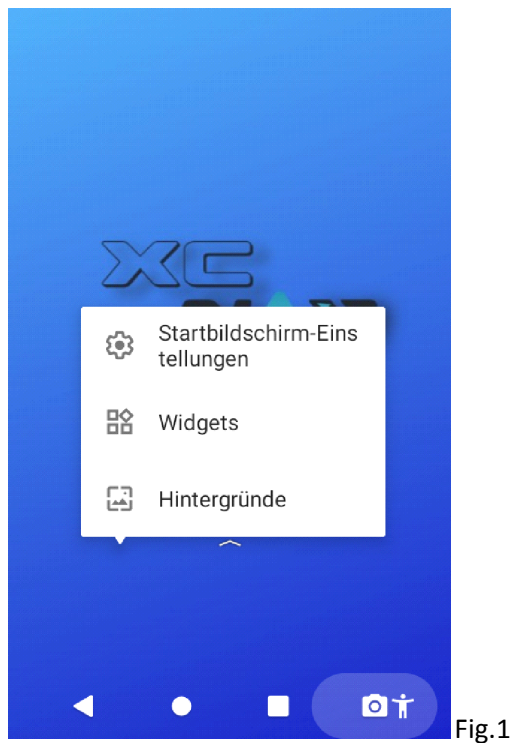

Fig.1

## 2.5 Moving an app to the home screen

Swipe from BOTTOM to UP on the home screen. The APP overview opens. (Fig. 2). Holding and moving an APP icon opens the start screen and a selection menu with "CANCEL" and "UNINSTALL".(Fig.3) The respective app can now be placed on the start screen by "drag and drop".

The "Favorites" are fixed in the bottom row. The apps stored there remain there, even if you scroll between the sites.

Fig.2.

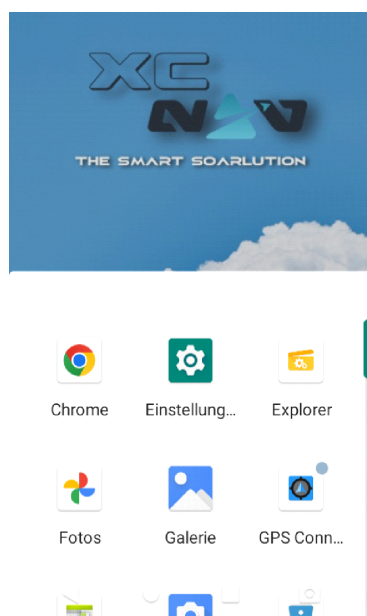
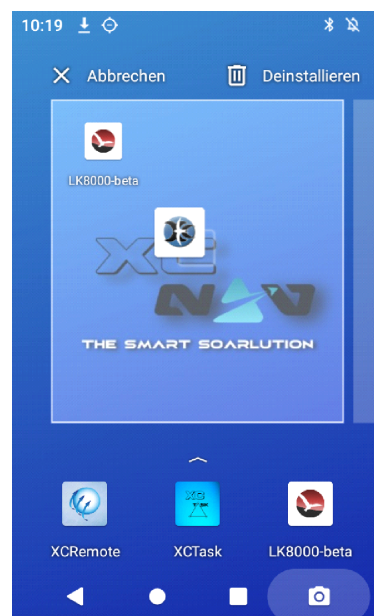

Fig.3



## 2.5 Widgets

Tab and hold anywhere on the touchscreen. This will open a menu. Select "WIDGETS". Widgets are small desktop programs. Here, for example, a clock can be added to the home screen.

## 3. APPS

When delivered, depending on the desired configuration XCSoar or LK8000 are fixed in the footer of the start screen. Swipe your finger from BOTTOM TO UP across the screen to open the APP overview (Fig.2). All apps installed on the device are stored here.

### 3.1 Installing an APP?

Android offers 2 ways to install apps on the device :

1. Google PlayStore: A Google account is required for this. The Google Play.Store is already preinstalled on our XCNAV Edition. Apps can be easily selected here and installed using the "Install" button.
2. Installation via an APK (Android Package). An .apk file is an installation file for Android apps. These can be offered by providers via websites such as GitHub, or through alternative Appstores such as [www.ApkPure.com](http://www.ApkPure.com). These are often apps that do not meet the strict, sometimes excessive, security requirements of Google Play. So, always be careful when installing an APP from an APK and only install it if you are sure of the source.If you have downloaded an .apk, look for the file in the "DOWNLOAD" folder, open the .apk and confirm the installation request.

### 3.2 Uninstall/Delete an APP

By holding and moving an APP icon to "UNINSTALL" in the pop -up menu (Fig.4) that appears (Fig.3).Here your App data can also be kept by ticking the box.

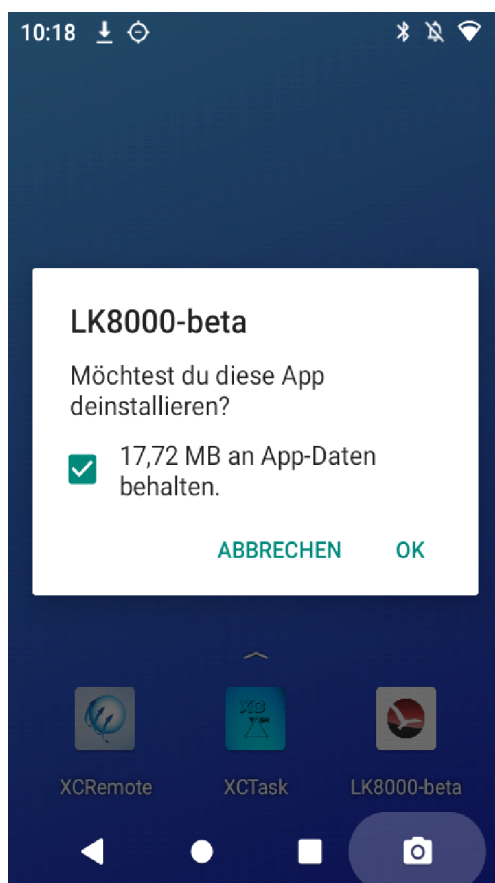

Fig. 4

## 4. Settings

The operating manual primarily deals with the settings that are relevant for the operation of the XCNAV EDITION in connection with XCSoAR and LK8000 and shows the default settings. A complete introduction to the Android structure and its possibilities would not be effective here. More detailed information and explanations can be found at [www.android.com/intl/de-de/](http://www.android.com/intl/de-de/).

-TBD-

## 5. Connections

Your XCNAV EDITION has various external connectors that allow easy integration into an existing cockpit environment .

The most important connectors for operation are on the back for a space-saving installation. In addition, there are other options on the side panel that can be used if space permits

## 5.1 Connectors

XCNAV EDITION offers the following connections on the back. (Fig. 1)

All connections are protected with a 500mA self-resetting polyfuse.



Fig.1

### 5.1.1 5V OUT

connection for peripheral devices such as XCREMOTE or USB chargers. The polarity must be observed! Protected by an internal 0.5A AutoFuse.

### 5.1.2 USB 2.0

2 x USB 2.0 e.g. for XCNAV GPS mouse, XCREMOTE etc.

### 5.1.3 S1

RS232 TTL Level, IGC Standard Pinout, for the connection of Varios, Flarm, loggers etc., as well fused with 0.5A. A Flarm or an XCVARIO up to `21 series can be connected with a 1:1 patch cable without any problems and is therefore supplied and secured. If galvanic isolation with extra protection is required, an extra cable must be assembled.

**ATTENTION:** Since the XCVARIO, starting series `22, has its CANBUS Signal on PIN2, a connection with a 1:1 cable would possibly damage the CANBUS of the XCVARIO . The proprietary interface S2 is available for this. If you want to connect an XCVARIO series `22 to S1, the connection cable must be modified.

In theory, the XCNAV EDITION can also be powered via S1 and S2. However, the maximum rating of 0.5A must also be observed . As soon as one or more additional interfaces are used (serial, USB or 5V), with a own consumption of approx. 270 mA for XCNAV Edition, this limit would quickly be reached.

ATTENTION: Pins 1&2 are directly connected to V IN , so the input voltage can pass unregulated! When operating the XCNAV EDITION in an on-board network other than 12V, it is essential to ensure that the devices connected through S1 and S2 are designed for the corresponding voltage!

## XCNAV EDITION S1

**1 11-35V**  
**2 11-35V**  
3 NIL  
4 NIL  
5 TX RS232 TTL  
6 RX RS232 TTL  
7 GND  
8 GND

87654321

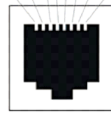

12345678

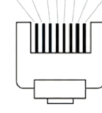

### 5.1.4 S2

With the exception of the assignment of PIN 2, connection S2 corresponds to the assignment of S1. Pin 2 is not assigned in S2. This ensures easy connection of an XCVario via a 1:1 patch cable .

## XCNAV EDITION S2

**1 11-35V**  
**2 NIL**  
3 NIL  
4 NIL  
5 TX RS232 TTL  
6 RX RS232 TTL  
7 GND  
8 GND

87654321

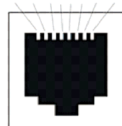

12345678

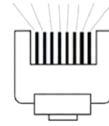



## 5.1.5 V In (11-35V)

Your XCNAV Edition works reliably with an applied voltage of 11-35 volts, so it can also be operated in a 24V environment. It should be noted that the created Voltage applied directly, i.e. unregulated, to S1 and S2!

The input is protected with a 3A auto fuse. Nevertheless we recommend an extra fuse so that XCNAV Edition can be removed from the power supply circuit separately in the event of a malfunction.

## 5.2 Sidepanel connectors

Besides the essential connectors on the back, XCNAV Edition offers additional connectors on the side which can be used if space permits. (Fig.1.)



Fig.1

### 5.2.1 SimCard Slot

With our XCNAV Edition, we take account of the orientation of modern aviation navigation apps towards connectivity, with an integrated LTE modem. A MicroSim is required for operation.

Since usually only small amounts of data are required, we recommend using a prepaid card, so you only pay for the period in which the card is used.

Caution: The online function is primarily intended for operation on the ground for flight preparation and post-use. Using it in flight can, depending on the installation

position, impair radio communication, like any mobile phone. Therefore, we recommend operating in flight mode during flight.

## 5.3.2 USB ports

There are two more USB ports: 1xUSB 2.0 and 1xUSB3.0 (blue). All USB ports are designed as USB host.

USB 3.0 can transfer data at up to 4.8 GBit/s. This is ten times faster than with USB 2.0, which is significantly slower at a maximum of 480 Mbit/s.

Another advantage of USB 3.0 is that it is full duplex. Data can therefore be transmitted in both directions AT THE SAME TIME. With USB 2.0, you can only transfer data in one direction at a time.

Furthermore, the maximum current of USB 3.0 has been increased from 500 mA to 900 mA.

The maximum cable length for USB 3.0 is limited to 3 meters. USB 2.0 cables can be up to 5 meters long.

USB 3.0 is fully backward compatible with USB 2.0. This means that a USB 2.0 stick can also be connected to a USB 3.0 port and a USB 3.0 stick will also work on a USB 2.0 port. On a 2.0 port, the data is not transferred any faster, even with a USB 3.0 stick. A USB 2.0 stick benefits from slightly faster transfer rates on a USB 3.0 port.

## 5.2.3 SD cards Terminal

XCNAV Edition supports cards up to 128GB in MicroSD format. To insert and remove the card, it must be locked/unlocked by pressing against the spring mechanism.

## 5.2.4 HDMI connection 2nd seat

Serves to connect the video and audio signal of the future XCNAV 2nd seat display.

## 5.2.5 Audio out

3 watt stereo audio out socket for 3.5 mm plug, for connecting an external speaker.

## 6.0 Connecting Peripherals

Connecting devices to your XCNAV Edition is very easy. In principle, a physical connection to the on board electrical system with a voltage of up to 35V is sufficient. Thanks to the Bluetooth capability, operation would be possible without an additional cable connection. You can operate up to 5 BT/BLE devices in parallel on your XCNAV Edition. (Eg Powerflarm + XCREMOTE + XCVARIO + KRT2 with BT)

Thanks to the serial interface with IGC standard, it is possible to connect non Bluetooth-capable devices via RJ45 network cable. Depending on the connected instrument a modified cable may be necessary

It should be understood that the supported functions of the connected peripherals depend primarily on the existing device drivers in the respective app used and not on the function of the XCNAV Edition.

In general, for a functioning serial connection, it must be ensured that the same baud rate is set both in the configuration settings of the respective app and on the peripheral devices.

Here are a few examples of the most common instruments:

### 6.1 Connection to XCVario

With the XCVario we have to distinguish between the XCVARIO20/21 and the `22 version. From XCVARIO22, PIN2 in S2 is assigned a CanBus signal. For this reason, PIN2 is not assigned with 12V on the XCNAV S2. This ensures direct connection with a 1:1 network cable. However, if an XCVario version `22 is to be connected to the XCNAV S1, the line for PIN2 must be disconnected or the optionally available splitter used in order not to damage the XCVARIO CAN-BUS.

By connecting a standard cable to S1 or S2, the XCVario is automatically supplied with power via pins 1 (V IN) and 8 (GND). This supply is fused with 0.5A self-resetting fuse. As soon as the supply voltage is present at V IN of your XCNAV Edition, the XCVario is supplied, regardless of the operating status of your XCNAV Edition. If a galvanic separation of XCNAV and XCVario is desired, the line on Pin ½ must be disconnected and the XCVario must be supplied via the supplied XCVario cable.

Make sure to set your XCVario as follows: Settings -> System -> S1/S2 -> Twist RX/TX Pins to "TWISTED"

Of course, the XCVARIO can also be connected to the XCNAV Edition via Bluetooth or WIFI. If a Flarm is connected via the XCVario, it is even advisable to establish an additional connection between XCVario and XCNAV Edition via BT and to configure it as FLARM in the XCSOAR settings (should the BT router function of the XCVario not be used to supply a 2nd device such as a mobile phone or tablet with data.) This guarantees a declaration and download from Flarm without changing the

configuration of XCSoar or LK8000. For detailed information I consult the XCVario operating manual in the "Flarm" chapter.

How can I distinguish XC Vario series?



Fig.1 Version 21/22



Fig2. Version 21

With version 22 the line

“Bat Meter/CAN: OK/OK”

is displayed in the BOOT MENU, not so with version `21

## XCVARIO

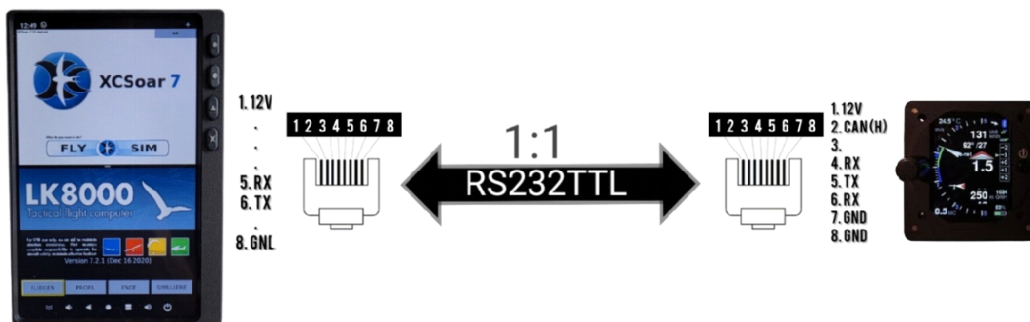

**1:1  
NUR  
S2**

**\*BEI ANSCHLUSS AN XCNAV  
S1 MUSS PIN 2 GETRENNT  
WERDEN UM DAS XCVARIO  
NICHT ZU BESCHAEDIGEN!**

## 6.2 Connection of Flarm

A Flarm with IGC standard assignment can easily be connected with a 1:1 cable to

both S1 and S2. It is then automatically supplied. When using an XCVario it is recommended to connect it to the XCVario using the cable supplied. Flarm data is then routed via the XCVario to the XCNAV Edition. Modern Flarm devices also provide the data via Bluetooth and can be connected to the XCNAV Edition in this way.

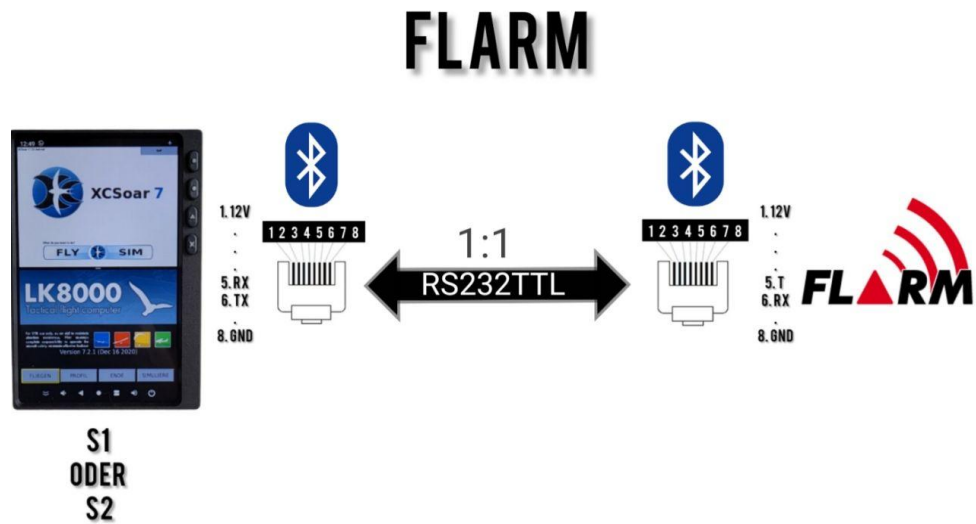

### 6.3 Connection LX S8x/S10X

A completely modified cable is required to connect an LX Vario. Here the PINS XCNAV RX with LX TX and XCNAV TX with LX RX and GND must be connected to each other. The connection via Bluetooth is also possible.

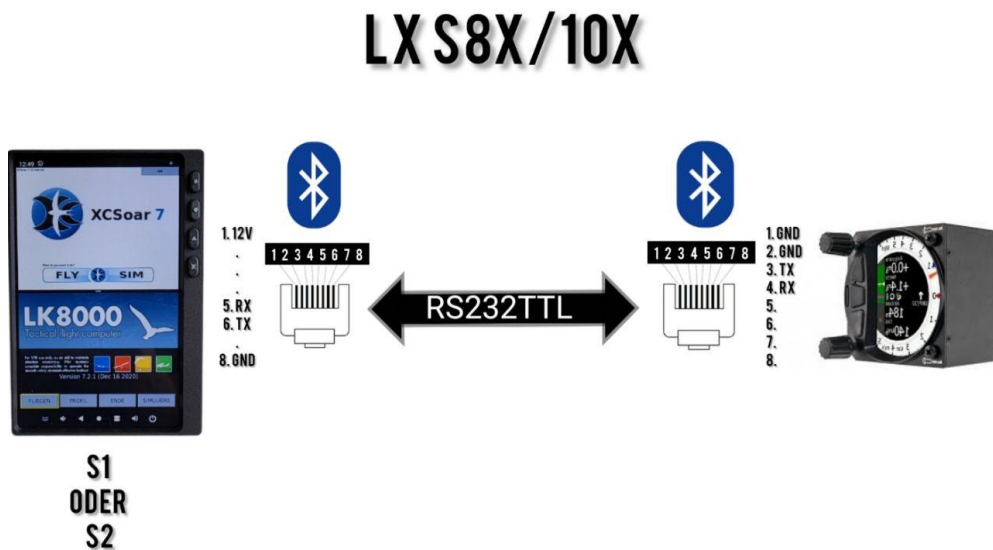

## 6.4 Connection LX EOS 57/80

A modified cable is also required for the LX EOS. With the appropriate cable, it can be connected to both S1 and S2. The LX Eos also offers the possibility of a BT connection.

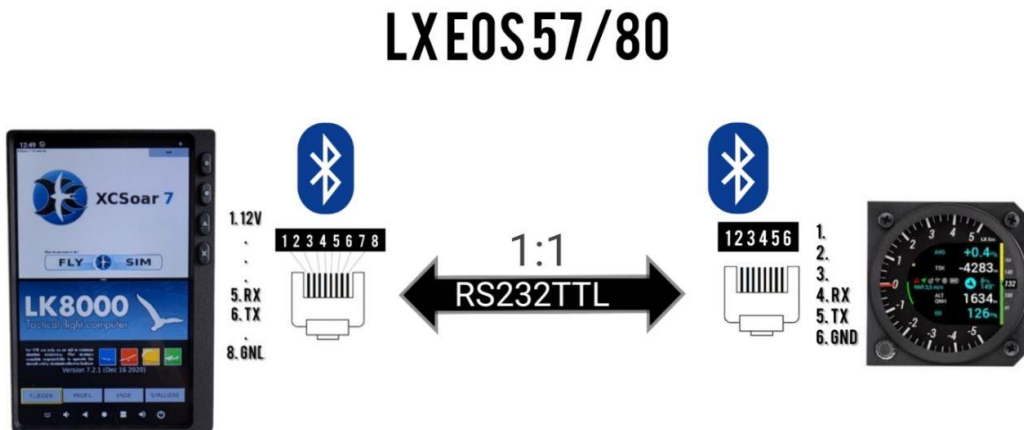

## 6.5 KRT 2 radio connection

KRT2 can be connected via S1 or S2 in order to set both the preselected and active frequency via XCSOAR or LK8000. To do this, connect pin 8 XCNAV Edition to GND or Pin1 of the SUB D connector, and pin 6 XCNAV to PIN 13 SUB D and PIN 5 connected to PIN 2 of the SUB D

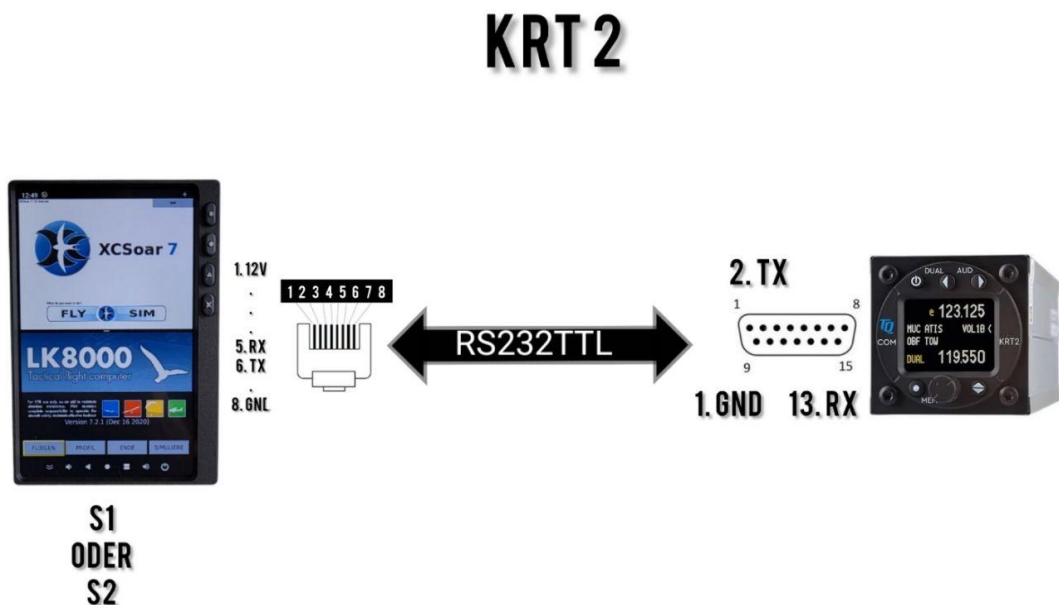

## 6.6 Example of XCVario, XCRemote and KRT2 connected to XCNAV Edition

It is recommended to connect the Flarm with the supplied XCVario cable to the XCVario on S1 (XCVario). The XCVario acts as a router here and forwards the Flarm data either via cable, WiFi or Bluetooth. The configuration instruction of the interface can be found in the XCVario manual. The XCVario can be connected with a standard 1:1 patch cable (set the RX/TX pins of the S2 interface of the XCVARIO to "TWISTED" under > Settings > System -> S1)

XCREMOTE is connected via BT. The cable is only to supply the remote with 5V and is not transmitting any data. It can be connected to any USB port or the 5V OUT connection of the XCREMOTE can be used for this. To use this, a JST PH 2-pin connector must be crimped to the supply line. We also offer this option when ordering the XCREMOTE!

Krt2 is then connected via S1 as described above.

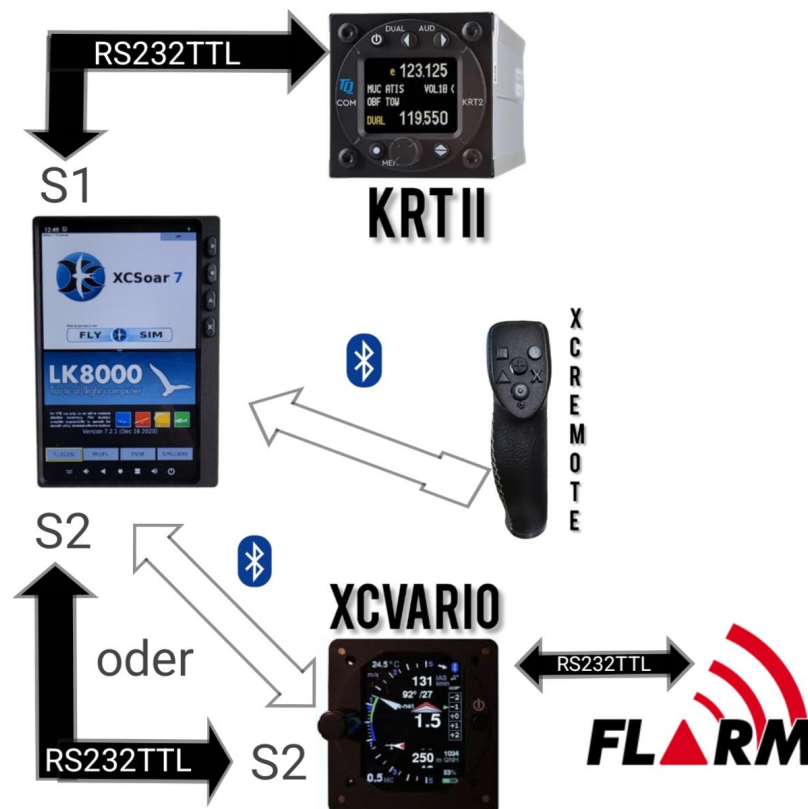

## 7.0 Assembly and electrical connection

For planning the instrument panel layout, there is a .dxf and a .stl file for a 3D printed cutting template on our Github page. This template than can be glued to the raw panel with double-sided tape to make the panel cut-out and drill mounting holes.

The XCNAV Edition is to be fastened with the four M3x0.5 screws supplied. If you use your own screws, ensure a maximum length of 9mm with a dashboard thickness of 3mm.

The XCNav Edition is extremely easy to integrate into the electrical system. The supplied cable must be used for this. XCNav Edition has an internal DC converter that allows an input voltage of up to 35V.

**CAUTION: THE APPLIED VOLTAGE IS TRANSMITTED TO PIN 1 AND 2 OF S1 AND PIN1 OF S2, UNFILTERED. WHEN CONNECTING TO AN ON-BOARD NETWORK WITH AN OPERATING VOLTAGE HIGHER THAN 12V, MAKE SURE THAT THE PERIPHERAL DEVICES CONNECTED AND SUPPLIED VIA S1 AND S2 ARE COMPATIBLE WITH THE SUPPLIED VOLTAGE**

V IN is protected internally with a self-resetting fuse of 3A. This is sufficient for safe operation. However, we still recommend the use of an additional circuit breaker or switch in order to be able to electrically isolate the device if necessary. As soon as a supply voltage is present at V IN, voltage is also present at S1 and S2, regardless of the operating state of the XCNAV Edition.

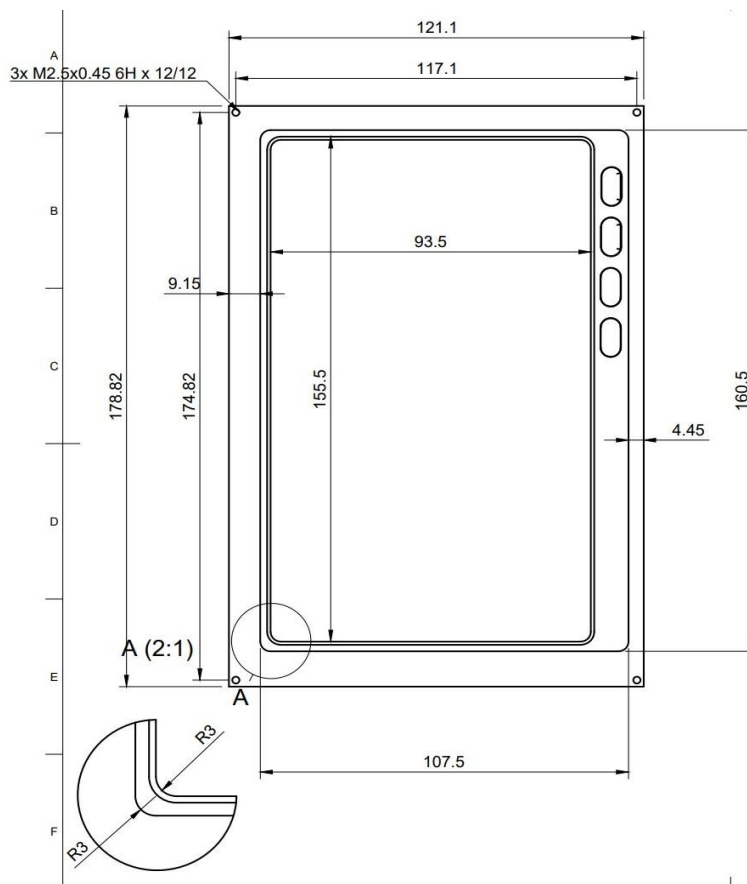



## 8. Technical data

- Overall dimensions approx: 179 x 121 x 46.5 mm
- Panel cut-out dimensions 160.5 x 108.5 mm
- Screen dimensions 156.5mm x 94.5mm
- Resolution 840 x 400 pixels
- Screen technology: Transflective/Blanview
- Highest contrast values
- Viewing angle stability: 80/80/80
- Min/Max storage temperature screen -40 degrees /95 degrees Celsius
- Min/Max screen operating temperature -30 degrees/85 degrees Celsius
- GPS receiver internal: No
- Pressure sensor internal: No
- Android 11
- 16GB ROM
- WiFi
- BT 4.1
- LTE modem
- Power consumption: approx. 300mAh/12.5V
- Power supply 11-35 Volt

## 9. Warranty conditions

The manufacturer provides a two-year warranty for the navigation system from the date of purchase with regard to repair effort and material costs. Within this period, components that fail under normal operating conditions will be repaired or replaced free of charge, provided the device was sent to the manufacturer free of charge.

The warranty does not cover damage caused by incorrect operation, misuse, accidents, unauthorized modifications or repairs, mechanical damage and the effects of heat, e.g. due to the burning glass effect of the hood on the display, lack of maintenance, demonstrably incorrect or faulty wiring.

According to the German Civil Code, the return can be made within 14 days of the date of purchase. In this case, the device and accessories must be returned by the buyer to XCNAV UG. The buyer bears the costs for this.

## 10. Approval

For each instrument, if the equipment is part of the minimum equipment list or requires an approval, it may only be installed if the supplier or manufacturer provides a document about the proper check for compliance with the respective specification of the individual piece of equipment, In the EASA area, this is usually the EASA Form One.

For all other equipment, as well as for standard parts, a corresponding examination and documentation of the same is not required (e.g. variometer, final approach computer, flight

data recording devices, navigation computer, additional antennas, batteries, cameras, additional pressure probes, mosquito cleaning systems, etc.). This is regulated in detail by EASA in AMC 21.A.303(c) 2, with the following wording:

----

#### AMC 21.A.303(c) Standard Parts

In this context a part is considered as a 'standard part' where it is designated as such by the design approval holder responsible for the product, part or appliance, in which the part is intended to be used. In order to be considered a 'standard part', all design, manufacturing, inspection data and marking requirements necessary to demonstrate conformity of that part should be in the public domain and published or established as part of officially recognized standards, or for sailplanes and powered sailplanes, where it is a non-required instrument and/or equipment certified under the provision of CS 22.1301(b), if that instrument or equipment, when installed, functioning, functioning improperly or not functioning at all, does not in itself, or by its effect upon the sailplane and its operation, constitute a safety hazard.

'Required' in the term 'non-required' as used above means required by the applicable certification specifications (CS 22.1303, 22.1305 and 22.1307) or required by the relevant operating regulations and the applicable Rules of the Air or as required by Air Traffic Management (Eg a transponder in certain controlled airspace).

Examples of equipment which can be considered standard parts are electrical variometers, bank/slip indicators ball type, total energy probes, capacity bottles (for variometers), final glide calculators, navigation computers, data logger / barograph / turnpoint camera, bug wipers and anti-collision systems. Equipment which must be approved in accordance with the certification specifications shall comply with the applicable ETSO or equivalent and is not considered a standard part (eg oxygen equipment).

-----

Thus, no EASA Form One is required for our navigation system and may be installed.

After installation, the equipment list of the aircraft must be adjusted, and if the mass of 0.5 kg (XCNAV Edition & XCVARIO) or 0.35 kg (XCNAV Edition only) more in the I board shows a relevant change in center of gravity, a weighing is carried out and the change will be released. When installing an XCVario, the pneumatic system must also be checked for leaks.

## 11. Limitation of Liability

With the purchase of the device, the customer agrees that no liability for any direct or indirect damage, claims for damages or consequential damage of any kind and for any legal reason arising from the use of the device.

The device is purely a tactical device for cross-country flights, so it is not part of the minimum instrumentation for gliders, and in case of doubt it must not be used as the primary source for controlling the aircraft, especially in critical flight phases. The target instrumentation is to be used for this. The device therefore does not require any FAA or EASA approval.



## **CE Declaration of Conformity**

### DECLARATION OF CONFORMITY

XCVario, CEO Markus Immig, Köpkenstraße 6, 28203 Bremen, declares that in normal configuration the XCNAV Edition hardware meets the requirements of the CE.

The EMC compatibility corresponds to EN 301 489-3:2002-08 for a Class 3 SRD device (equipment type I).

